OLED Hotel TV with Premier IP & RF Solution

EU961H

The world's best-selling OLED brand, LG OLED TV, embraces cutting edge Hospitality management technology - LG Pro:Centric SMART. It delivers greater usability and convenience for seamless exploration of TV content, and also provides great solutions for hotel management.



OLED Hotel TV with Premier IP&RF Solution EU961H

World's Number 1 OLED

Perfect Black. Intense Color

LG OLED TV provides richness in all colors, boasts aesthetic touch of nature, and reveals life. Equipped with over 8 million of self-lightning pixels operating individually, the product completes the Perfect Black.



4K Cinema HDR

LG 4K Cinema HDR offers the filmmaker's vision through usage of HDR formats. Now, a unique cinematic experience is available at hotel room with Dolby Vision™ and HDR 10.



OLED Hotel TV with Premier IP&RF Solution EU961H

World's Number 1 OLED

Cinematic Sound for Your Home

Dolby Atmos® creates a dynamic and surround sound experiences although even when space is limited, facilitating the discernment of every details of the movement in a scene. With Dolby Vision™, the product provides a truly unique cinematic experience.



Picture-on-Glass, the Artistic Esthetics

Furnished with sleek design, the product takes its artistic aspect to the next level. As the need for distinct elements like bezel or a thick stand has been eliminated, the refined but aesthetically stifled design intensifies the viewing experience.



OLED Hotel TV with Premier IP&RF Solution EU961H

World's Number 1 OLED

OLED Gallery Mode

Bring the wonders of the world to your Hotel space with OLED Gallery Mode. From photography of beautiful places to world-renowned artwork, Gallery Mode provides a great selection of beautiful images and videos. Stunning contents creates a perfect atmosphere that suits your visitor's mood.



* Actual images(In-screen of TV) available may differ from the above simulated ones.

OLED Hotel TV with Premier IP&RF Solution

EU961H

Pro:Centric Smart Application Platform

Pro:Centric Hotel Management Solution

Pro:Centric SMART is optimized for customizing hospitality services for hotel brands and guests through an IP & RF infrastructure. With its high picture quality, sophisticated design and advanced connectivity functions, it upscales in-room entertainment and increases convenience through implementation of high-end technology.

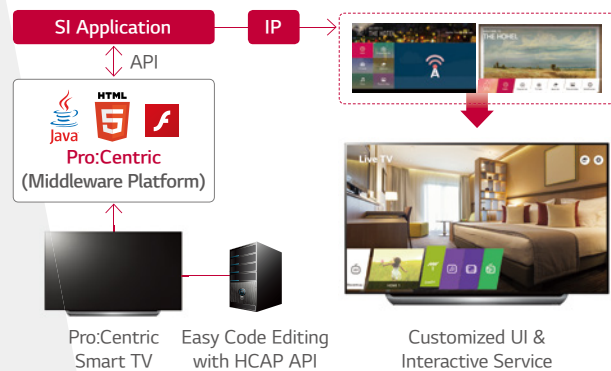

* Actual UI may differ

Pro:Centric Server Application

You can now differentiate your hotel with our customizable templates and pages which can be specialized for your property. Pro:Centric provides you a solution that is easily customizable for your business.

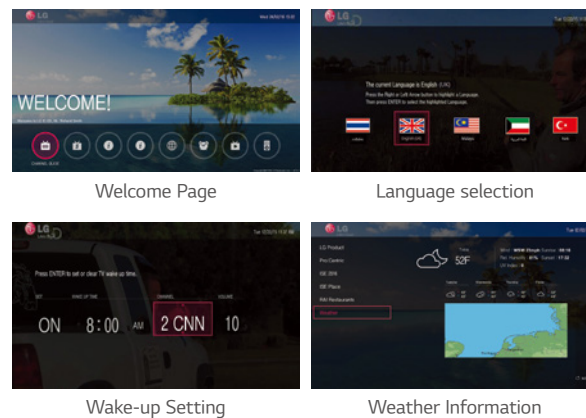

Pro:Centric Direct Solution

Pro:Centric Direct is a hotel content management system that supports simple editing tools and provides various solutions such as 1-click service and IP-network-based remote management. With the solution, users enable to design UI easily and provide customized service while managing TV efficiently.

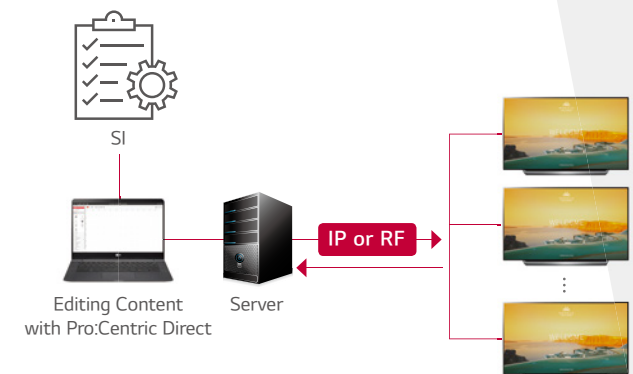

* Customized UI may differ

* When PCS400R and PCD 2.0 are used, it is able to have PCD feature even in RF infrastructure. However, to have interactive services in RF infrastructure, Wi-Fi is required (RF+Wireless Infrastructure is needed).

Dimension

65"

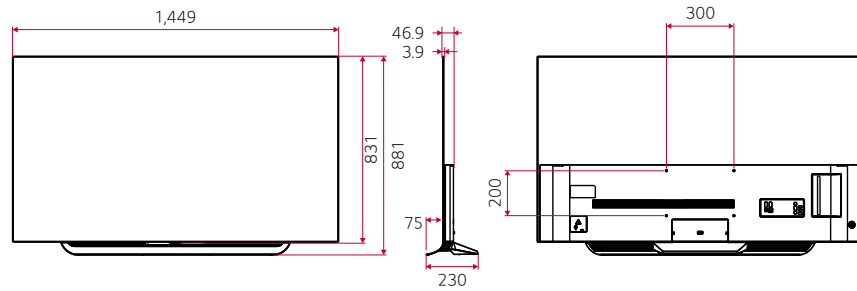

55"

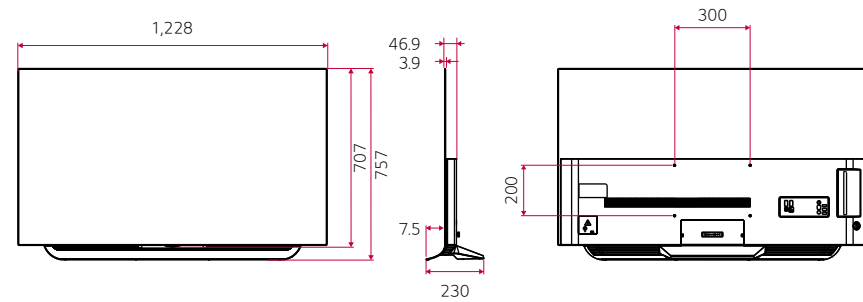

Connectivity

65"

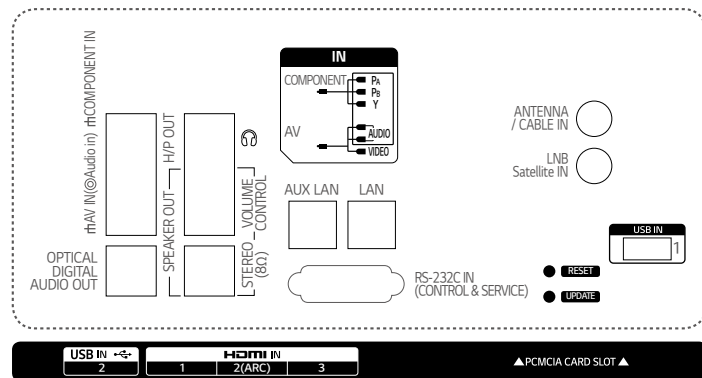

55"

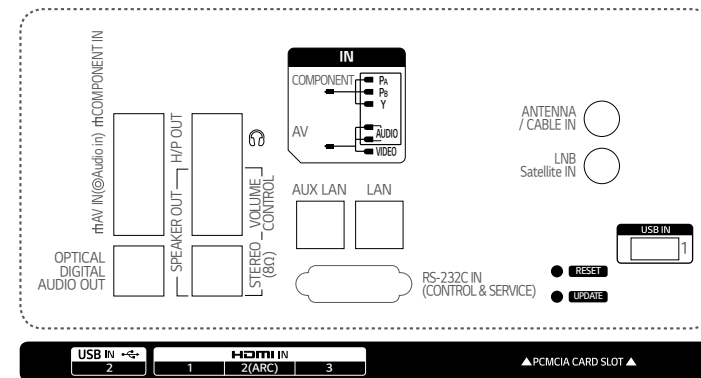

* Dimensions & Jack Panels (Read/Side) may differ from the above image, so please contact LG salesteam to verify before ordering.

Specifications

65EU961H (EU/CIS)

55EU961H (EU Only)

PANEL	Screen Size	65"	55"
	Backlight Type	OLED	OLED
	Resolution	3,840 x 2,160 (4K UHD)	3,840 x 2,160 (4K UHD)
	Brightness (cd/m ²)	500	500
	Dynamic Contrast Ratio (Dynamic MCI (Hz))	1,000,000:1	1,000,000:1
	Static (Panel) Contrast Ratio	150,000:1	150,000:1
	Viewing Angle Degree	120	120
BROADCASTING SYSTEM	Response Time (G to G, ms)	1	1
	Analog	• (PAL/SECAM)	• (PAL/SECAM)
VIDEO	Digital	• (varied by countries)	• (varied by countries)
	XD Engine	•	•
AUDIO	Aspect Ratio	• 6 modes (16:9, Original, Full wide, 4:3, Vertical Zoom, All-Direction Zoom)	
	HDR 10 / HDR Dolby Vision	• / •	
AUDIO	Audio Output	20W + 20W	20W + 20W
	Speaker System	2.2 ch	2.2 ch
	Sound Mode	• 6 modes (Standard, Cinema, Clear Voice III, Sports, Music, Game)	
	Clear Voice	• (Clear Voice)	• (Clear Voice)
	Dolby Atmos	•	•
	Adaptive Sound Control	•	•
	One Touch Sound Tuning	•	•
	Audio Channel	•	•
HOSPITALITY SOLUTIONH	Solution Type	• (Smart, Direct, V)	• (Smart, Direct, V)
	Data Streaming (IP & RF)	•	•
	RF (1/2Tuner)	• (1 Tuner)	• (1 Tuner)
	HCAP (GEM/FLASH/HTML Service Carousel (TLL/XML)	GEM / Flash / HTML5	GEM / Flash / HTML5
	Pro:Centric Application (version)	PCA 3.8	PCA 3.8
DRM	Pro:Idiom	Pro:Idiom	
SMART FEATURE	webOS 4.0, OLED Gallery Mode, Commercial Smart Home, Quick Access, Voice Recognition, IoT (TBD), Web Browser, Pre-loaded App, SDP Server Compatibility, Magic Remote Compatibility (MR18BA only), Soft AP, Wi-Fi (ac), Screen Share (Miracast), Smart Share (DLNA), LG TV Plus App, DIAL, Bluetooth Audio Playback, LG Sound Sync/bluetooth, Mobile Connection Overlay, Music Player		
FUNCTION	EzManager(Simplicity), USB Cloning, Wake on RF, WOL, SNMP, Remote Diagnostics, SI Compatible (TVLink Interactive), HTNG-CEC (1.4), HDMI-CEC (1.4), IR Out, Multi IR Code, Auto Off / Sleep Timer, Smart Energy Saving, Motion Eye Care		
HOSPITALITY FEATURES	Hotel Mode / PDM / Installer Menu, Lock Mode (Limited), Welcome Screen (Splash Image), Insert Image, One Channel Map, External Speaker Out, Instant ON, External Power, V-Lan Tag, RJP Interface, RJP Compatibility, External Clock Compatibility, Clock (World Clock / Alarm), 360 Viewer, Healthcare Headphone Mode		
JACK INTERFACE	Set Side	HDMI In 2.0 (3), USB 2.0, CI Slot	HDMI In 2.0 (3), USB 2.0, CI Slot
	Set Rear	RF In (2), AV In, Component in (YPb,Pr-Video), Digital Audio Out (Optical), USB 2.0, RS-232C (Control & Service), Headphone Out, RJ45 (2), External Speaker Out	
DIMENSION (UNIT : mm)	VESA Compatible	300 x 200	
	W x H x D / Weight (with stand)	1,449 x 881 x 230 / 26.1kg	1,228 x 757 x 230 / 19.1kg
	W x H x D / Weight (without stand)	1,449 x 831 x 3.9 (SPK: 46.9) / 21.7kg	1,228 x 707 x 3.9 (SPK: 46.9) / 16.3kg
POWER (UNIT : WATTS)	W x H x D / Weight (Packing)	1,660 x 970 x 207 / 33.7kg	1,345 x 810 x 207 / 24.4kg
	Voltage, Hz	100 ~ 240V, 50/60Hz	100 ~ 240V, 50/60Hz
POWER (UNIT : WATTS)	Typical	409.7	309
	Stand-by	0.3	0.3

* Specifications are subject to change without notice, so please contact LG salesteam to verify before ordering.



LG B2B Ukraine
str. Novokonistyninovskaya 2
04080 Kyiv, Ukraine
E-mail: info@lg-b2b.com.ua
www.lg-b2b.com.ua

www.lg-b2b.com.ua <https://www.facebook.com/LGB2BUkraine>
All screen images are simulated. Dimension and weights are approximate.
Design, features and specifications subject to change without notice.
© Copyright 2019 LG Electronics Inc. All Rights Reserved. Pro:Centric, the "LG" logo, are registered trademarks or trademarks of LG Electronics Inc. All other trademarks or registered trademarks are the property of their respective owners.

